

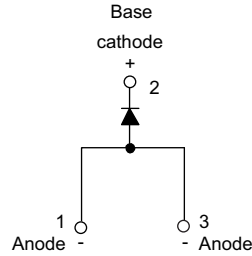

## Fast Soft Recovery Rectifier Diode, 80 A



TO-247AC



### FEATURES

- Glass passivated pellet chip junction
- 150 °C max. operating junction temperature
- Low forward voltage drop and short reverse recovery time
- Designed and qualified according to JEDEC®-JESD 47
- Material categorization: for definitions of compliance please see [www.vishay.com/doc?99912](http://www.vishay.com/doc?99912)



**RoHS**  
COMPLIANT  
HALOGEN  
**FREE**  
Available

PRODUCT SUMMARY	
Package	TO-247AC
$I_{F(AV)}$	80 A
$V_R$	200 V, 400 V, 600 V
$V_F$ at $I_F$	1.25 V
$I_{FSM}$	1000 A
$t_{rr}$	70 ns
$T_J$ max.	150 °C
Diode variation	Single die
Snap factor	0.5

### APPLICATIONS

These devices are intended for use in output rectification and freewheeling in inverters, choppers and converters as well as in input rectification where severe restrictions on conducted EMI should be met.

### DESCRIPTION

The VS-80APF0... soft recovery rectifier series has been optimized for combined short reverse recovery time and low forward voltage drop.

The glass passivation ensures stable reliable operation in the most severe temperature and power cycling conditions.

MAJOR RATINGS AND CHARACTERISTICS			
SYMBOL	CHARACTERISTICS	VALUES	UNITS
$V_{RRM}$		200 to 600	V
$I_{F(AV)}$	Sinusoidal waveform	80	A
$I_{FSM}$		1000	
$t_{rr}$	1 A, - 100 A/ $\mu$ s	70	ns
$V_F$	40 A, $T_J = 25$ °C	1.1	V
$T_J$	Range	-40 to +150	°C

VOLTAGE RATINGS			
PART NUMBER	$V_{RRM}$ , MAXIMUM PEAK REVERSE VOLTAGE V	$V_{RSM}$ , MAXIMUM NON-REPETITIVE PEAK REVERSE VOLTAGE V	$I_{RRM}$ AT 150 °C mA
VS-80APF02PbF, VS-80APF02-M3	200	300	17
VS-80APF04PbF, VS-80APF04-M3	400	500	
VS-80APF06PbF, VS-80APF06-M3	600	700	



ABSOLUTE MAXIMUM RATINGS				
PARAMETER	SYMBOL	TEST CONDITIONS	VALUES	UNITS
Maximum average forward current	$I_{F(AV)}$	$T_C = 95\text{ }^\circ\text{C}$ , 180° conduction half sine wave	80	A
Maximum peak one cycle non-repetitive surge current	$I_{FSM}$	10 ms sine pulse, rated $V_{RRM}$ applied	850	
		10 ms sine pulse, no voltage reapplied	1000	
Maximum $I^2t$ for fusing	$I^2t$	10 ms sine pulse, rated $V_{RRM}$ applied	3610	$A^2s$
		10 ms sine pulse, no voltage reapplied	5100	
Maximum $I^2\sqrt{t}$ for fusing	$I^2\sqrt{t}$	$t = 0.1\text{ ms to }10\text{ ms}$ , no voltage reapplied	51 000	$A^2\sqrt{s}$

ELECTRICAL SPECIFICATIONS				
PARAMETER	SYMBOL	TEST CONDITIONS	VALUES	UNITS
Maximum forward voltage drop	$V_{FM}$	80 A, $T_J = 25\text{ }^\circ\text{C}$	1.25	V
Forward slope resistance	$r_t$	$T_J = 150\text{ }^\circ\text{C}$	3.5	$m\Omega$
Threshold voltage	$V_{F(TO)}$		0.85	V
Maximum reverse leakage current	$I_{RM}$	$T_J = 25\text{ }^\circ\text{C}$	17	$mA$
		$T_J = 150\text{ }^\circ\text{C}$		

RECOVERY CHARACTERISTICS				
PARAMETER	SYMBOL	TEST CONDITIONS	VALUES	UNITS
Reverse recovery time	$t_{rr}$	$I_F$ at 40 A <sub>pk</sub> 25 A/ $\mu$ s 25 °C	190	ns
Reverse recovery current	$I_{rr}$		3.4	A
Reverse recovery charge	$Q_{rr}$		0.5	$\mu$ C
Snap factor	S		0.5	

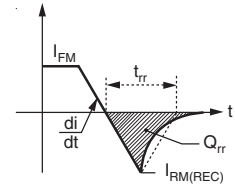

THERMAL - MECHANICAL SPECIFICATIONS				
PARAMETER	SYMBOL	TEST CONDITIONS	VALUES	UNITS
Maximum junction and storage temperature range	$T_J, T_{Stg}$		-40 to +150	$^\circ\text{C}$
Maximum thermal resistance, junction to case	$R_{thJC}$	DC operation	0.35	$^\circ\text{C/W}$
Maximum thermal resistance, junction to ambient	$R_{thJA}$		40	
Typical thermal resistance, case to heatsink	$R_{thCS}$	Mounting surface, smooth, and greased	0.2	
Approximate weight			6	g
			0.21	oz.
Mounting torque	minimum		6 (5)	$\text{kgf} \cdot \text{cm}$ $(\text{lbf} \cdot \text{in})$
	maximum		12 (10)	
Marking device		Case style TO-247AC	80APF02	
			80APF04	
			80APF06	

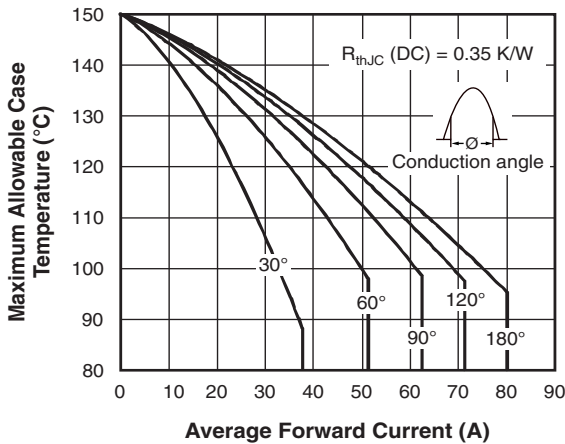

Fig. 1 - Current Rating Characteristics

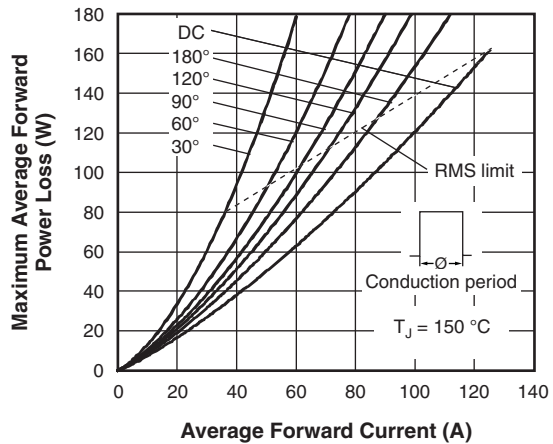

Fig. 4 - Forward Power Loss Characteristics

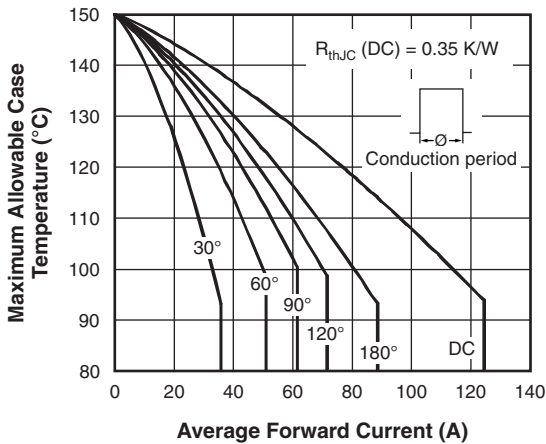

Fig. 2 - Current Rating Characteristics

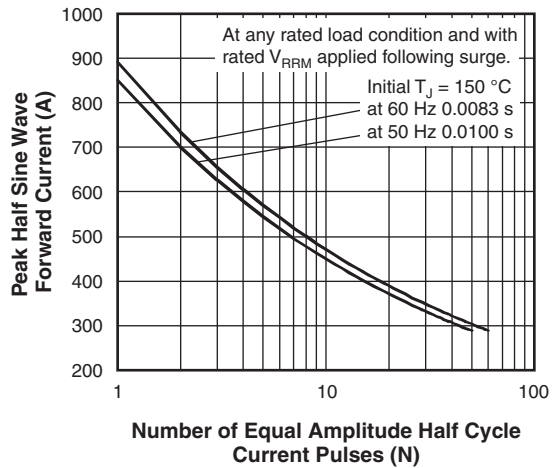

Fig. 5 - Maximum Non-Repetitive Surge Current

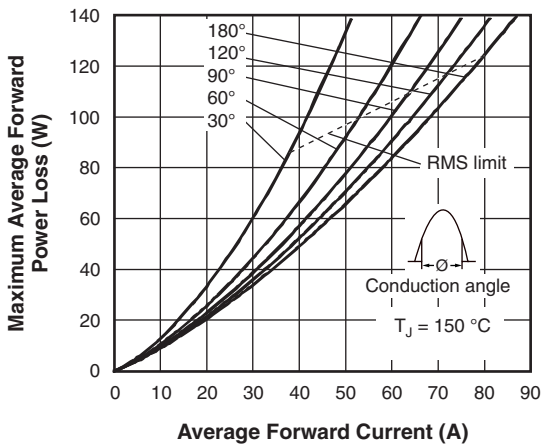

Fig. 3 - Forward Power Loss Characteristics

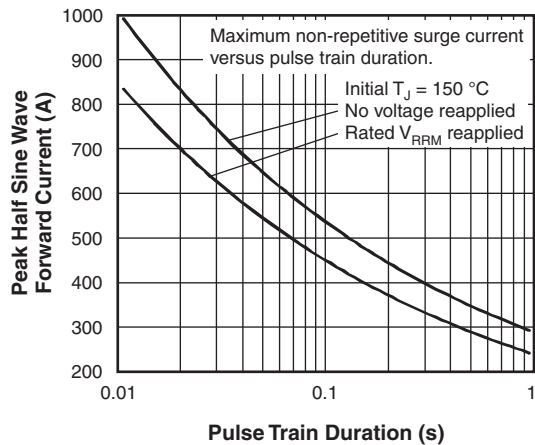

Fig. 6 - Maximum Non-Repetitive Surge Current

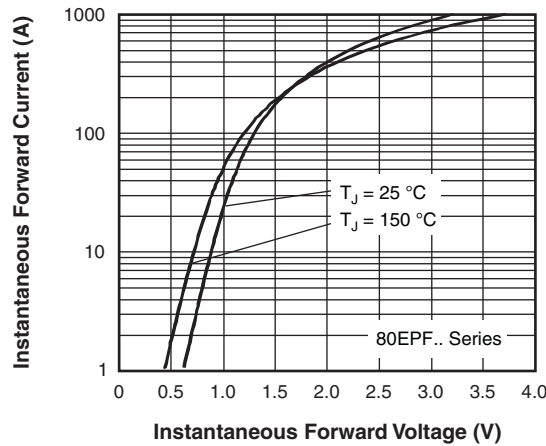

Fig. 7 - Forward Voltage Drop Characteristics

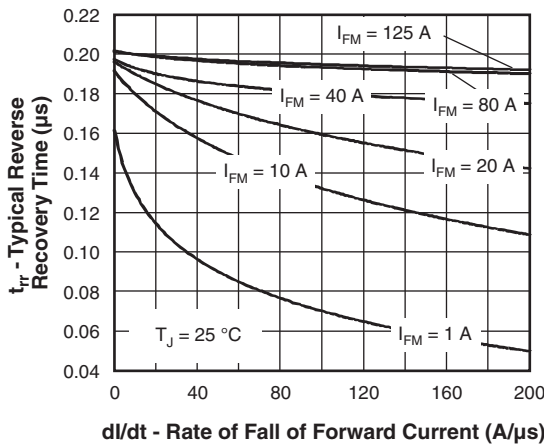

Fig. 8 - Recovery Time Characteristics,  $T_J = 25\text{ °C}$

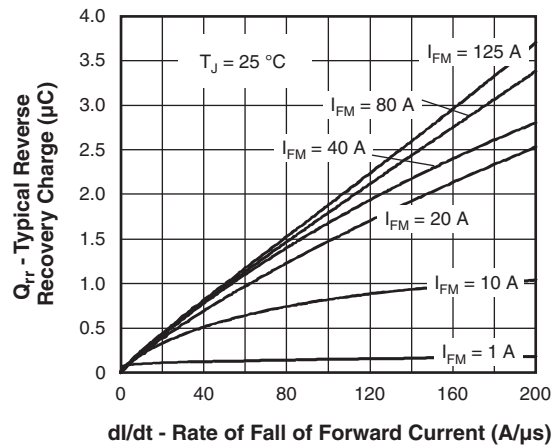

Fig. 10 - Recovery Charge Characteristics,  $T_J = 25\text{ °C}$

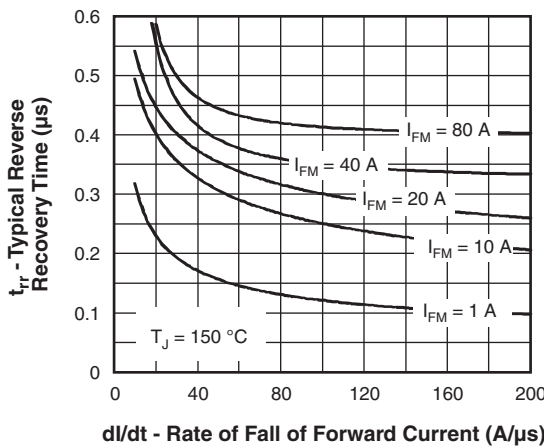

Fig. 9 - Recovery Time Characteristics,  $T_J = 150\text{ °C}$

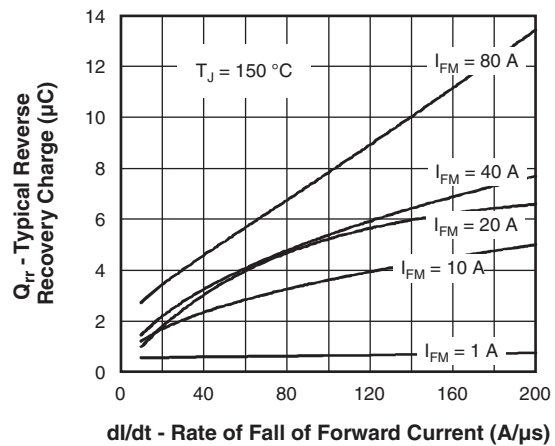

Fig. 11 - Recovery Charge Characteristics,  $T_J = 150\text{ °C}$

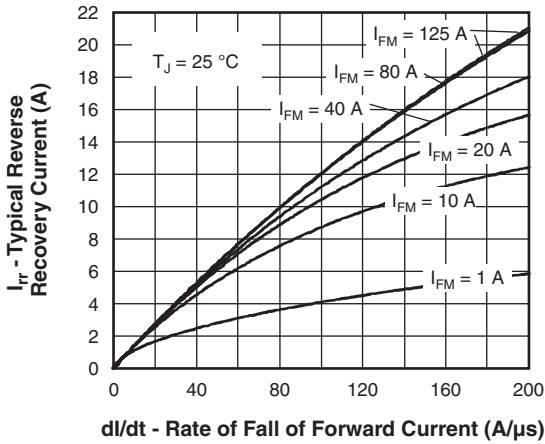

Fig. 12 - Recovery Current Characteristics,  $T_J = 25\text{ }^\circ\text{C}$

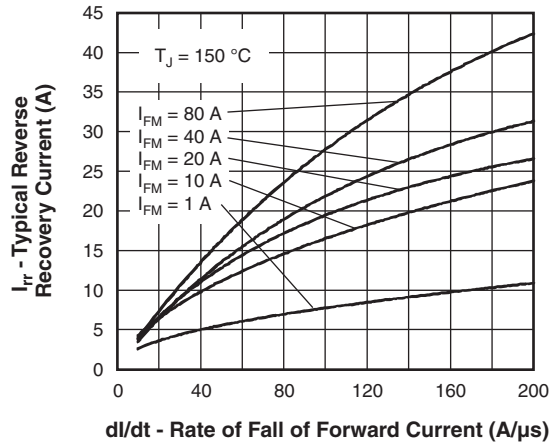

Fig. 13 - Recovery Current Characteristics,  $T_J = 150\text{ }^\circ\text{C}$

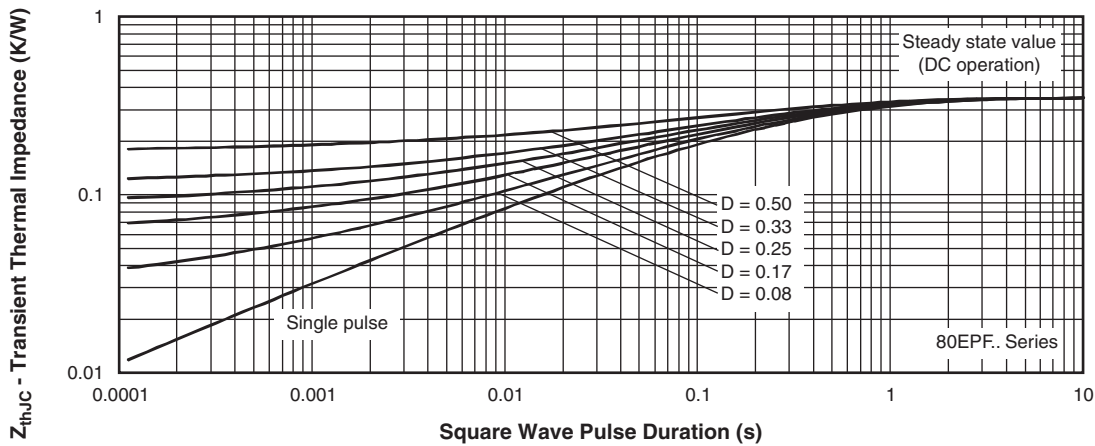
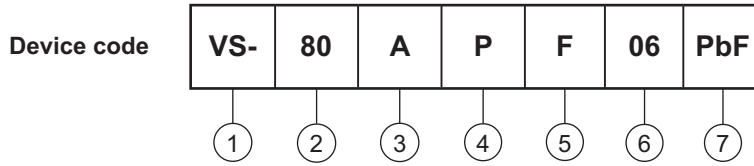

Fig. 14 - Thermal Impedance  $Z_{thJC}$  Characteristics



## ORDERING INFORMATION TABLE



- 1** - Vishay Semiconductors product
- 2** - Current rating (80 = 80 A)
- 3** - Circuit configuration:  
A = single diode, 3 pins
- 4** - Package:  
P = TO-247AC
- 5** - Type of silicon:  
F = fast recovery
- 6** - Voltage code x 100 =  $V_{RRM}$ 

02 = 200 V
04 = 400 V
06 = 600 V
- 7** - Environmental digit:
  - PbF = lead (Pb)-free and RoHS-compliant
  - -M3 = halogen-free, RoHS-compliant, and terminations lead (Pb)-free

ORDERING INFORMATION (Example)			
PREFERRED P/N	QUANTITY PER T/R	MINIMUM ORDER QUANTITY	PACKAGING DESCRIPTION
VS-80APF02PbF	25	500	Antistatic plastic tubes
VS-80APF02-M3	25	500	Antistatic plastic tubes
VS-80APF04PbF	25	500	Antistatic plastic tubes
VS-80APF04-M3	25	500	Antistatic plastic tubes
VS-80APF06PbF	25	500	Antistatic plastic tubes
VS-80APF06-M3	25	500	Antistatic plastic tubes

LINKS TO RELATED DOCUMENTS	
Dimensions	<a href="http://www.vishay.com/doc?95542">www.vishay.com/doc?95542</a>
Part marking information	TO-247AC PbF <a href="http://www.vishay.com/doc?95226">www.vishay.com/doc?95226</a>
	TO-247AC -M3 <a href="http://www.vishay.com/doc?95007">www.vishay.com/doc?95007</a>



# TO-247 - 50 mils L/F

**DIMENSIONS** in millimeters and inches

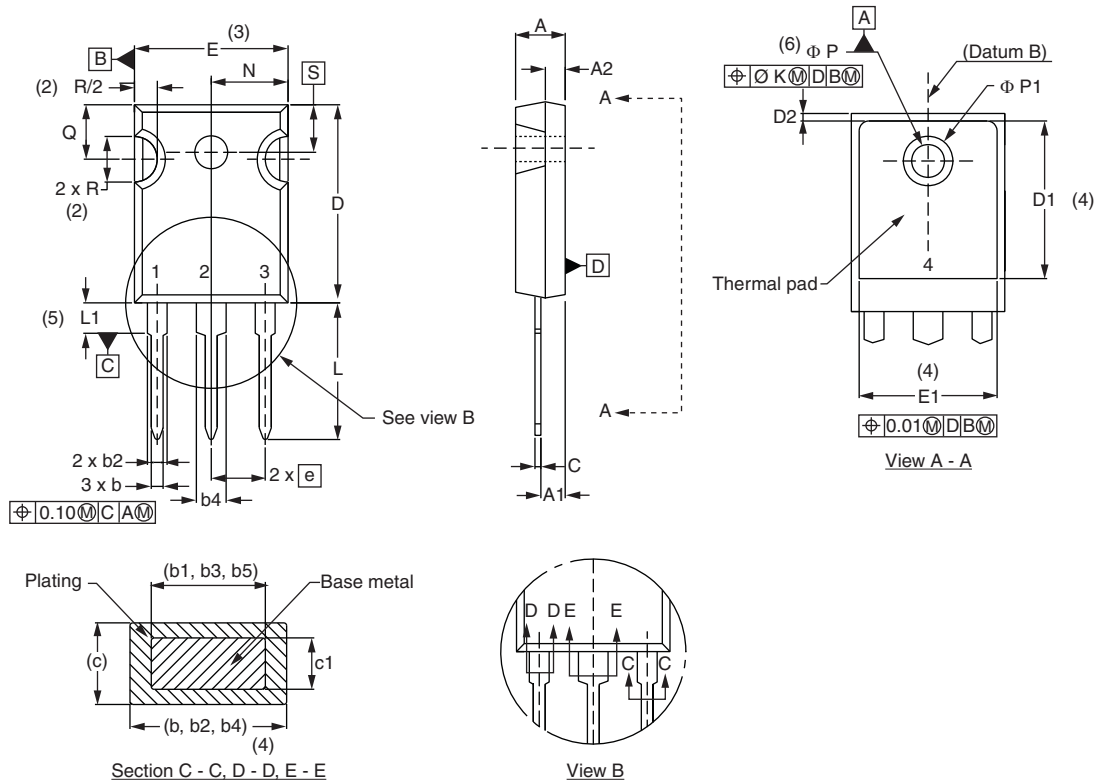

SYMBOL	MILLIMETERS		INCHES		NOTES	SYMBOL	MILLIMETERS		INCHES		NOTES
	MIN.	MAX.	MIN.	MAX.			MIN.	MAX.	MIN.	MAX.	
A	4.65	5.31	0.183	0.209		D2	0.51	1.35	0.020	0.053	
A1	2.21	2.59	0.087	0.102		E	15.29	15.87	0.602	0.625	3
A2	1.17	1.37	0.046	0.054		E1	13.46	-	0.53	-	
b	0.99	1.40	0.039	0.055		e	5.46 BSC		0.215 BSC		
b1	0.99	1.35	0.039	0.053		$\varnothing$ K	0.254		0.010		
b2	1.65	2.39	0.065	0.094		L	14.20	16.10	0.559	0.634	
b3	1.65	2.34	0.065	0.092		L1	3.71	4.29	0.146	0.169	
b4	2.59	3.43	0.102	0.135		N	7.62 BSC		0.3		
b5	2.59	3.38	0.102	0.133		$\varnothing$ P	3.56	3.66	0.14	0.144	
c	0.38	0.89	0.015	0.035		$\varnothing$ P1	-	7.39	-	0.291	
c1	0.38	0.84	0.015	0.033		Q	5.31	5.69	0.209	0.224	
D	19.71	20.70	0.776	0.815	3	R	4.52	5.49	0.178	0.216	
D1	13.08	-	0.515	-	4	S	5.51 BSC		0.217 BSC		

**Notes**

- (1) Dimensioning and tolerancing per ASME Y14.5M-1994
- (2) Contour of slot optional
- (3) Dimension D and E do not include mold flash. Mold flash shall not exceed 0.127 mm (0.005") per side. These dimensions are measured at the outermost extremes of the plastic body
- (4) Thermal pad contour optional with dimensions D1 and E1
- (5) Lead finish uncontrolled in L1
- (6)  $\varnothing$  P to have a maximum draft angle of 1.5 to the top of the part with a maximum hole diameter of 3.91 mm (0.154")
- (7) Outline conforms to JEDEC® outline TO-247 with exception of dimension c and Q



## Disclaimer

ALL PRODUCT, PRODUCT SPECIFICATIONS AND DATA ARE SUBJECT TO CHANGE WITHOUT NOTICE TO IMPROVE RELIABILITY, FUNCTION OR DESIGN OR OTHERWISE.

Vishay Intertechnology, Inc., its affiliates, agents, and employees, and all persons acting on its or their behalf (collectively, "Vishay"), disclaim any and all liability for any errors, inaccuracies or incompleteness contained in any datasheet or in any other disclosure relating to any product.

Vishay makes no warranty, representation or guarantee regarding the suitability of the products for any particular purpose or the continuing production of any product. To the maximum extent permitted by applicable law, Vishay disclaims (i) any and all liability arising out of the application or use of any product, (ii) any and all liability, including without limitation special, consequential or incidental damages, and (iii) any and all implied warranties, including warranties of fitness for particular purpose, non-infringement and merchantability.

Statements regarding the suitability of products for certain types of applications are based on Vishay's knowledge of typical requirements that are often placed on Vishay products in generic applications. Such statements are not binding statements about the suitability of products for a particular application. It is the customer's responsibility to validate that a particular product with the properties described in the product specification is suitable for use in a particular application. Parameters provided in datasheets and / or specifications may vary in different applications and performance may vary over time. All operating parameters, including typical parameters, must be validated for each customer application by the customer's technical experts. Product specifications do not expand or otherwise modify Vishay's terms and conditions of purchase, including but not limited to the warranty expressed therein.

Except as expressly indicated in writing, Vishay products are not designed for use in medical, life-saving, or life-sustaining applications or for any other application in which the failure of the Vishay product could result in personal injury or death. Customers using or selling Vishay products not expressly indicated for use in such applications do so at their own risk. Please contact authorized Vishay personnel to obtain written terms and conditions regarding products designed for such applications.

No license, express or implied, by estoppel or otherwise, to any intellectual property rights is granted by this document or by any conduct of Vishay. Product names and markings noted herein may be trademarks of their respective owners.