

NEW

Next-Generation Production Environment Sensors

EQUO™ Series

OMRON

Precision Thermo-Humidity Logger

ZN-THS-S (Sensor head)

ZN-THX11-SA (Logger)



Easy temperature and humidity control with an SD Card



Sensor head

Logger

realizing

Meeting the need for “easier management of temper

Omron Precision Thermo-Humidity Loggers use sensors with the highest precision in their class and the first SD Card. This enables precise control of temperature and humidity at multiple points along the manufacturing line and more. The logger has alarm output providing immediate alerts when trouble occurs, helping meet strict quality control.

First in its class!

SD Card system makes data collection more efficient

- Data can be collected only when needed by simply inserting an SD Card
- Thermo-Humidity Logger memory can store up to approx. 8,500 pieces of data
- Measured data is transferred to CSV format and stored in an SD Card
- Data continues to be recorded in built-in memory even while data is being collected onto SD Card
- Store data up to maximum memory capacity by keeping SD Card continually inserted (approx. 17 million pieces of data per 1GB. Store up to five years of data when measurements are made every 10 seconds)

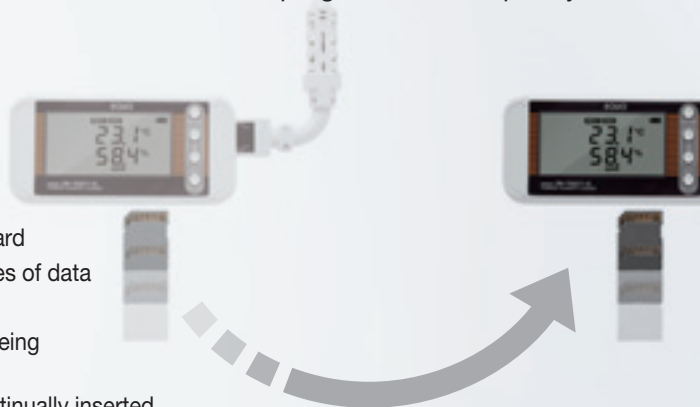

Compact body with useful features!

* Photo shows actual size

Large, easy to read characters!

Large, easily legible LCD display has two rows of five characters.

Easy operation similar to portable gaming device

Start recording with the touch of a single button!

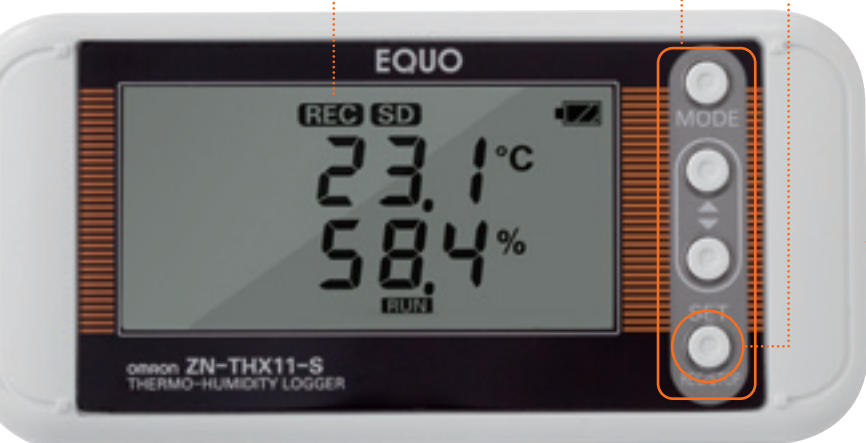

Runs for approx. 1 year on two commercial AAA batteries

With built-in backup feature, stored data won't be lost even if batteries run out

- * In sleep mode. Battery life may vary depending on production environment and battery type / battery performance.
- * Manganese batteries cannot be used.

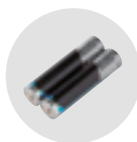

Can also be used with DC voltage input or AC adaptor



Easy to hang on wall as well

Back side features two types of holes, for wall-hanging and for anchoring

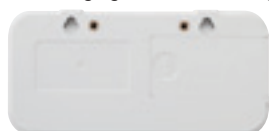

SD Card slot



Alarm output terminal

Top in its class

Remarkably high measurement accuracy

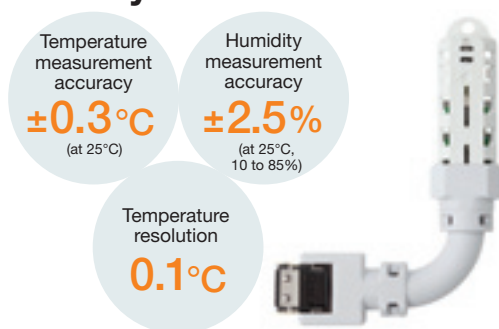

Precision measurement ensures a temperature resolution of 0.1°C and humidity accuracy of plus/minus 2.5%. This enables more precise control of temperature and humidity, which contributes to improvement in product quality.

Specifications

Sensor head

Item		Model	ZN-THS17-S	ZN-THS17C-S*	ZN-THS11-S	ZN-THS11C-S*
Appearance						
			Sensor head: Anchored type		Sensor head: 1.5 m type	
Temperature	Measurement range		0 to 60°C		-25 to 60°C	
	Measurement precision		±0.3°C (at 25°C)			
	Resolution		0.1°C			
Relative humidity	Measurement range		20 to 85%		0 to 99%	
	Measurement precision		±2.5% (at 25°C, 10 to 85%)			
	Resolution		0.1%			
Weight (packaged)			Approx. 300 g			
Accessories			Mounting screw (M3 x 8) x 1 Caps to secure cable (one for each, front and rear)		Mounting screw (M3 x 8) x 1	

* Please choose this form when you buy it with the calibration certificate.

- As performance may deteriorate through the adhesion of impurities or contaminants in the environment on the sensor surface, calibration is recommended once a year.
- When ZN-THS1□□-S is exposed over a long period of time at a high humidity of 80% or higher, the humidity measurement value may be offset.
- In that case, expose the product at room temperature and humidity for 24 hours prior to use.
- When ZN-THS1□□-S is transferred rapidly between places where temperature difference is large, condensation may occur on the sensor surface. In that case, the ZN-THS1□□-S may not work properly. When the product becomes wet due to condensation, allow the product to dry in a dry, room temperature environment before use.
- When using the ZN-THS1□□-S under conditions with temperatures of -20°C or less or with humidity of 90% or more, acceleration of sensor deterioration may occur.
- To avoid deterioration of sensor, avoid storing the product under high temperature and high humidity for a long period of time.
- Please don't use the product in an environment into which organic chemistry material disperses.

ature and humidity data”

data collection system.
efficient data collection.
standards.



Quick and easy data collection with a single SD Card!

Stunningly simple!
No need to detach the unit itself.
No need for PC or other collection equipment.



First in its class!

Alarm output for immediate response when trouble occurs

Example: When temperature exceeds threshold value, an error indicator lights up



The logger has an alarm output. Unusual temperature and humidity are made visible, enabling you to make a quick response and to make it easy to systemize manufacturing lines.

PC Software

Create graphs easily by simply designating the SD Card drive!

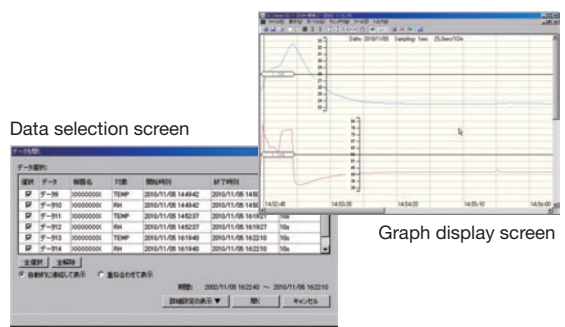

Insert the SD card containing collected data into a PC, and simply designate the drive in order to manage and graph the recorded data. Measurement data is stored in CSV format, allowing for easy temperature and humidity data management.

Note: Download the PC Software Station Utility from the following OMRON website (<http://www.fa.omron.com.jp/station-u-e>).

Logger

Item	Model	ZN-THX11-SA
Appearance		
Sensor that can be connected		Thermo-Humidity Sensor Head (ZN-THS1□□-S)
Display		LCD 7-segment 5-digit 2-step display, auxiliary information indicator display
Measurement interval		10 s, 20 s, 30 s, 1 min, 2 min, 5 min, 10 min, 20 min, 30 min, 1 h
Calculation function		Instantaneous value, maximum value, minimum value, average value
Operating mode		Normal mode, sleep mode*1
Recording mode		Continue*2, ring*3
Alarm signal output*4		Output to photocoupler (External power supply: 12 to 24 VDC, Load current: Max. 45 mA) Alarm hold setting is possible.*5
Internal storage device		Internal memory: Approx. 8,500 data items
External storage device		SD card (to save measured values and to save/read set values), Recommended SD card: HMC-SD291 (manufactured by OMRON)*8
Power supply voltage		DC input: 24 VDC±10% Battery: 2 AAA batteries*5
Battery life*5		Approx. 1 year*6 (sleep mode, measurement interval of 10 minutes with 2 AAA nickel metal hydride batteries, with SD card not inserted)
Operating temperature range		0 to 60°C
Operating humidity range		20 to 85% (no condensation)
Weight (packaged)		Approx. 500 g
Accessories		Instruction Sheet, Startup1 Guide, Alarm output connector*7, DC cable (straight type)

Calibration service

Subject to calibration	Content	Model
Sensor head Anchored type	Certificate of Calibration, Test Transcript Traceability chart	ZN-THS17-CAL
Sensor head 1.5 m type	Certificate of Calibration, Test Transcript Traceability chart	ZN-THS11-CAL

* As the sensor head and station are digitally connected, this calibration service is available only for the sensor head.
* It is necessary to ship the product back to OMRON in Japan.

Accessories (Order separately)

Item	Model	
Mounting Magnet*	ZN9-EM01-S	
DC cable (ZN9-ED01-S comes with ZN-THX11-SA)	Straight type	ZN9-ED01-S
	Right angle type	ZN9-ED02-S
AC Adaptor for ZN-□□X-S 100 to 240 VAC/50 to 60 Hz Operating temperature range: 0 to 40°C	PSE, CE, UL STD/A-type plug	ZN9-ACP01-S

* When the magnet is used, the vibration resistance becomes 55 Hz or less. (Two logger installation screws are attached.)
*1 Power saving mode. The indicator is always OFF in default setting. (Turns ON with button operation.)
*2 Automatically writes data to the SD card when reaching the upper limit of the internal memory and keeps recording until the capacity limit of the SD card. If the SD card is not inserted when the internal memory reaches the upper limit, recording stops. (Data can be output to the SD card by pressing the button after inserting the SD card.)
*3 This mode always records the latest measured values for the upper limit of the internal memory. (When the measured values exceed the upper limit of the internal memory, the data items will be deleted beginning with the oldest data item.)
*4 An alarm is shown when exceeding the upper limit value or lower limit value that has been set in threshold setting mode.
*5 Nickel hydride battery and alkaline battery can be used. Manganese batteries cannot be used.
*6 Battery life differs depending on measurement environment, sampling, operating mode, battery type, or performance.
*7 The connector is type XW4B-Q2B1-H1, made by OMRON.
*8 If you use an SD card from another manufacturer, use an SDHC Class 4 or higher card. (You must confirm the operation of the SD card yourself.)

Dimensions (unit: mm)

[Logger] ZN-THX11-SA

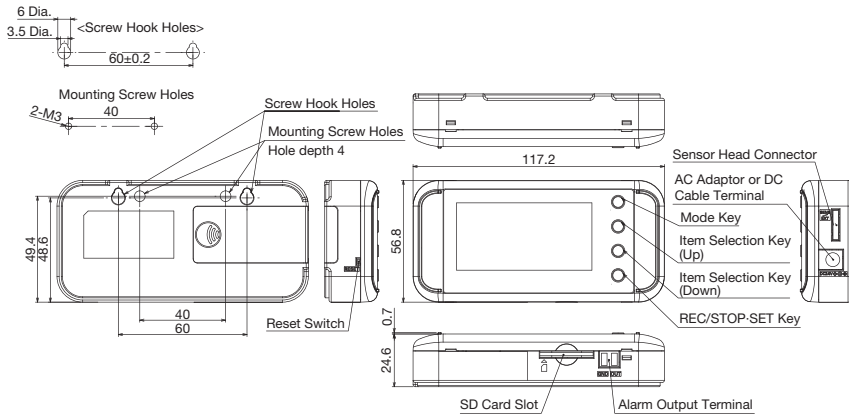

[Sensor Head]

ZN-THS17-S

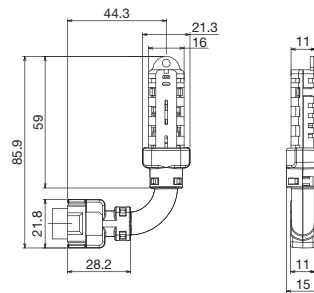

ZN-THS11-S

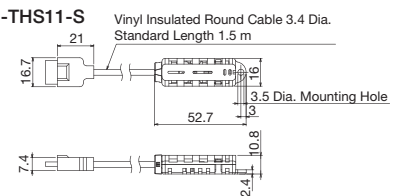

In addition to Thermo-Humidity Logger...

LAN Connection models also available

Thermo-Humidity Station

Integrated networked monitoring of temperature and humidity data



Differential Pressure Station

Use to control positive pressure in clean booths!



Continuous monitoring of production environments is easy with LAN-connection models.

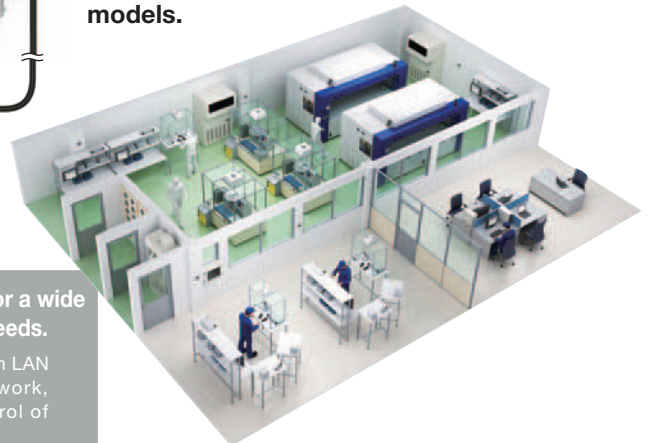

Clearly visualize your entire production environment including temperature, humidity, airborne particles, dust fallout, and differential pressure!

LAN connection models are ideal for a wide variety of continuous-monitoring needs.

LAN connection models feature a built-in LAN port. Data can be retrieved via a network, allowing for efficient, integrated control of equipment and production environment.



Built-in LAN port

* Windows is a registered trademark of Microsoft Corporation in the United States and other countries.

OMRON Corporation Industrial Automation Company
Tokyo, JAPAN

Contact: www.ia.omron.com

Regional Headquarters

OMRON EUROPE B.V.
Sensor Business Unit
Carl-Benz-Str. 4, D-71154 Nufringen, Germany
Tel: (49) 7032-811-0/Fax: (49) 7032-811-199

OMRON ASIA PACIFIC PTE. LTD.

No. 438A Alexandra Road # 05-05/08 (Lobby 2),
Alexandra Technopark,
Singapore 119967
Tel: (65) 6835-3011/Fax: (65) 6835-2711

OMRON ELECTRONICS LLC

One Commerce Drive Schaumburg,
IL 60173-5302 U.S.A.
Tel: (1) 847-843-7900/Fax: (1) 847-843-7787

OMRON (CHINA) CO., LTD.

Room 2211, Bank of China Tower,
200 Yin Cheng Zhong Road,
PuDong New Area, Shanghai, 200120, China
Tel: (86) 21-5037-2222/Fax: (86) 21-5037-2200

Authorized Distributor:

© OMRON Corporation 2011 All Rights Reserved.
In the interest of product improvement,
specifications are subject to change without notice.

CSM_3_1_1116
Cat. No. E409-E1-01

Printed in Japan
0611 (0611) (TA)